

World Ionosphere/ Thermosphere Study

WITS HANDBOOK

Volume 2

Edited by

C. H. Liu

December 1989

Published for the ICSU Scientific Committee on Solar-Terrestrial Physics (SCOSTEP)
with financial assistance from Unesco subvention through a 1989 grant from ICSU

Copies available from the SCOSTEP Secretariat,
University of Illinois, 1406 W. Green St., Urbana, Illinois 61801

PROSPECTS OF TOPSIDE SOUNDING

S. A. Pulinets
Institute of Terrestrial Magnetism, Ionosphere and Radiowave Propagation
USSR Academy of Sciences, IZMIRAN
Troitsk, Moscow Region 142092, USSR

1. Introduction

Since the first swallow flight of the Canadian "Alouette", more than 25 years ago, many satellites with onboard topside sounders produced by different countries have been put in orbit. From the source of discoveries in the 1960s, the topside sounders turned into hard workers like their ground-based brothers.

The interpretation and processing of topside ionograms reached the same level of automation as the bottomsides ones [Reinisch and Huang, 1982; Huang and Reinisch, 1982]. But nevertheless topside sounding did not shift from the experimental category to routine applications. The gap between topside sounders appearing in orbit even under the efforts of different countries consists of several years. There still exists no national or international system of global monitoring of the ionosphere by the topside sounding technique despite the convincing results of previous satellites. The lack of ionospheric information for the large territories of the ocean and land is one more weighty argument for the creation of a topside sounding global monitoring system. This is one point the present paper will discuss.

The next points of interest are the new techniques in topside sounding such as trans-ionospheric sounding, using stimulated resonances, and natural and artificial noises registered on topside ionograms for monitoring ionospheric parameters.

One can find comprehensive information on the traditional methods of topside sounding in the IEEE Special Issue on Topside Sounding and the Ionosphere [1969], hence in this paper emphasis will be made on nontraditional techniques and on the problems of global monitoring of the ionosphere.

2. The Family of Topside Sounders

The name "topside sounder" formally can be given to more than ten instruments launched by different countries onboard satellites Alouette 1, (1962), Explorer (1964), Alouette-2 (1965), ISIS-I (1969), Cosmos-381 (1970), ISIS-B (1964), ISS-A (1976), ISS-B (1978), EXOS-B (1978), Interkosmos-19 (1979), EXOS-C (1984), Cosmos 1809 (1986), ISEE-1 and 2 (1978), but in fact they could be divided into several groups according to inherent ideas and parameters. Such sounders like Explorer or Cosmos-381 working on several fixed frequencies only proved the possibility of pulsed radio-sounding from onboard the satellite, but they have nothing to do with global monitoring of electron density in large frequency and height domains.

The second group of satellites like EXOS-B, EXOS-C [Oya et al., 1985] or ISEE 1 and 2 [Gurnett et al., 1978] could be named only "relaxation sounders" from the point of view of their tasks and organizing of their work onboard the satellites. They did have a possibility to receive signals reflected from the ionosphere and even sometimes the whole ionogram but their main purpose was stimulation of plasma waves. Their sounding was not systematic from the geophysical point of view.

The rest of the sounders could be divided into three groups according to their technical parameters and contribution to ionospheric science.

2.1 Alouette and ISIS group

The first one is the US-Canadian group including the ISIS-B sounder working from 1974 up to now. The first discoveries concerning the equatorial anomaly, main trough, diurnal, seasonal and other kinds of upper ionosphere variability were made first onboard these satellites. This group of sounders is well described by Franklin and Maclean [1969]. Their technical parameters are presented in Table 1. I'd like to remind you of the main features inherent to these sounders which essentially differ them from other representatives of the family. The fundamental one is their substantially analogous character. Hence the frequency step or resolution is determined by the relation between the sweep rate and pulse repetition frequency. For this reason the fixed grid of frequencies does not exist in contrast to digital sounders. Due to the very small sweep rate, especially in the low frequency range, the frequency step (8.35 kHz) is more narrow than the overall bandwidth of the receiver (40 kHz). This feature made it possible to study in detail the stimulated plasma resonances [Benson, 1982], to observe the sidebands of emitted pulses [Warnock, 1969], to detect the signals emitted during the previous frequency step when the receiver tuned already to the next frequency step [Muldrew, 1969; Vidmar and Crawford, 1985], to study in detail the low frequency natural noises such as AKR [Benson and Calvert, 1979; Benson, 1985; James, 1980].

One interesting feature of the sounder regimes was the special "mixed" mode of operation when the sounder transmitter operated on fixed frequencies during frequency sweep of the receiver [Benson, 1982]. In combination with switching of emitted power it made possible to study nonlinear wave processes and their thresholds. The dubious was selection of orbit heights. Apogee for Alouette-2 was 2980 km and for ISIS-1 the apogee was 3500 km. The oblique and ducted traces appearing on the ionograms [Muldrew, 1969] introduced unnecessary complexity in ionogram interpretation and scaling. The main shortcoming of this group of projects was the absence of high capacity memory. This is the principal limitation for global mapping tasks. Nevertheless, they were the first, and most of the results obtained did not lose the actuality and became a cornerstone for modern knowledge of the ionosphere.

2.2 ISS-B sounder

The next representative of the ionosonde family was the topside sounder launched from the second attempt in February 1978 onboard the Japanese satellite ISS-B [Nishizaki et al., 1982]. The principal parameters of the sounder are shown in Table 2. The main difference from ISIS-like satellites is the digital-generated grid of frequencies with a step of 100 kHz. From the point of view of resolution it is a more rough device in frequency domain and apparent range domain, but in this project a big advance was made from the point of view of global mapping [Atlas of Ionospheric Critical Frequency, 1979] and onboard processing of sounder information. The new nontraditional techniques were used for monitoring ionospheric parameters. These techniques will be discussed in a separate paragraph.

As concerns mapping, the main means was the onboard tape recorder with the recording time of 115 min, which is nearly equal to satellite orbit period (107 min). In the mode TOP-B when the topside ionograms were obtained, the sequence of measuring was 64 s with ionogram duration of 16 s. So during the recording time nearly 100 ionograms were stored, representing a whole revolution around the Earth. Every day 3-4 such orbits were transmitted to the ground-based telemetry station. Taking into account the shift of the satellite orbit in local time, 12 min per day, nearly four months were necessary to build the set of UT maps (see Figure 1), but the problem of mapping will be discussed in section 3. A result of the project was a series of summary plots and maps for the different periods of the satellite activity published by the Radio Research Laboratory of the Japan Ministry of Posts and Telecommunications [Summary Plots, 1983]. It was the main contribution of the project to ionospheric science.

Table 1

**SUMMARY OF SYSTEM PARAMETERS FOR THE
ALOUETTE AND ISIS TOPSIDE SOUNDERS**

	Alouette I	Alouette II	ISIS-I	ISIS-B
Sweep range (MHz)	0.5 - 12	0.12 - 14.5	0.1 - 10 0.1 - 20	0.1 - 10 0.1 - 20
Sweep rate (MHz/s)	≈ 1	≈ 0.13 below 2 MHz ≈ 1 above 2 MHz	0.31(0.1-2 MHz) 0.88(2-5 MHz)	0.375(0.1-2MHz) 1.125(2-5 MHz)
Frame time (s)	18	32	19 or 29	14 or 21
Fixed frequencies (MHz)	-	-	0.25 0.48 1.00 1.95 4.00 9.303 0.82*	0.25 0.48 1.00 1.95 4.00 9.303
PRF(Hz)	63	30	30 and 60	45
Pulse width (μs)	100	100	98	87
Transmitter power (W)	100	300	400	400
Receiver AGC attack time (ms)	12	520 (below 2 MHz) 60 (above 2 MHz)	60	60
Decay time (ms)	46	120 (below 2 MHz) 12 (above 2 MHz)	12	12

*Resonance mode only

Table 2

ISS-B SPECIFICATION PARAMETERS

Frequency range	0.5 - 14.8 MHz
Frequency step	100 kHz
Pulse width	300 μs
Pulse peak power	150 W
Pulse repetition rate	9 Hz
Bandwidth of the receiver	7 kHz
Sampling of echo signals	33.3 km in apparent range

UT=18H TOP-A' FOF2 UT-MAP ISS-B [ALL]
1978,282 ΔUT=02H:223.00.00(2370)-346.00.00(4009}

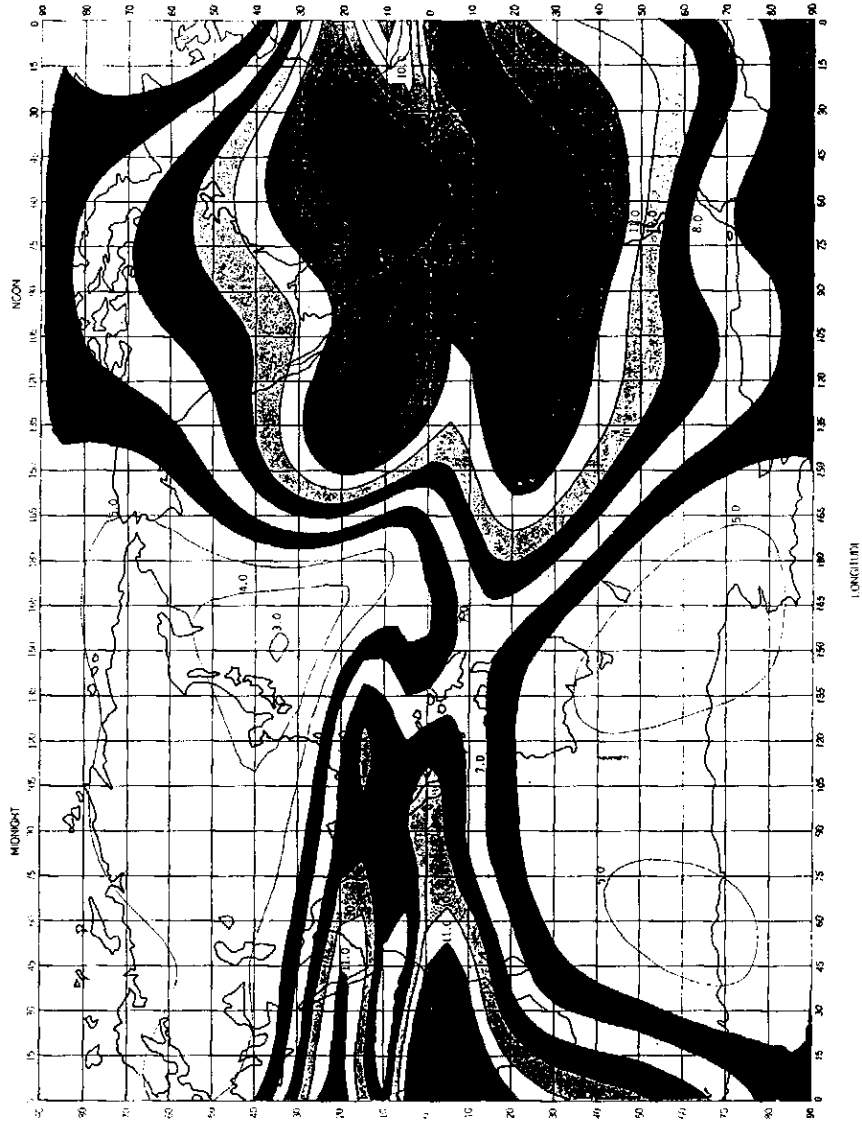

Figure 1. Example of ISS-B global UT-map.

It is necessary to mention the new approach to the automation of the topside ionograms processing [Igi and Aikyo, 1986]. It concerns mainly the automatic identification of the resonance spikes but the algorithm (see Figure 2) suggested could be used for onboard processing of the ionograms and automatic identification of O and X traces without polarization measurements.

2.3 IS-338 sounder

Dealing with many ionospheric scientists I heard the regret about the absence of detailed information in English concerning the Soviet topside sounder. To fill this gap I feel a necessity to adduce here a short description of the sounder. The principal designer of this satellite ionospheric station was Dr. G. V. Vasiliyev [Vasiliyev et al., 1980a,b]. It was installed onboard two satellites: Interkosmos-19 (February 1979-March 1982, inclination 74, perigee 500 km, apogee 980 km) and Cosmos-1809 (December 1986 - June 1989, inclination 82.5, circular orbit with height 960-980 km). In principle, the general functional diagram onboard both satellites did not differ except for the new system of ionogram coding on the Cosmos 1809 satellite. The system consisted of the sounder itself, antenna system, coding device and operative memory (onboard Cosmos 1809 -- two coding devices) (Figure 3). The antenna system consisted of two crossed dipoles 50 m tip-to-tip and 15 m tip-to-tip and filters of high and low frequencies. The dipoles were situated parallel to the Earth's surface and under 45° to velocity vector of the satellite (Figure 4). The satellite was 3-axes stabilized. The sounding in the lower frequency band up to 5 MHz was carried out on the 50 m dipole and in the higher frequency range from 5 MHz on the short 15 m dipole. The sounder parameters are displayed in Table 3.

The timeframe and composite video signal are shown in Figure 5. Depending on telemetry memory mode, the sounder is switched on by the sync pulse every 8, 16, 32, or 64 s (Figure 5a) but the ionogram duration is always 6.04 s. Information about the switching of the sounder in the form of 6.04 s pulse is transmitted by the telemetry (Figure 5b) and special pulse is used for control of the onboard devices (Figure 5c). It is necessary to have in mind that some delay of 0.3 - 0.5 s takes place from the switching sync to the beginning of sounding. This time is used for the reaching of stationary state of all electronic circuits after the power supply switches on. Every ionogram starts with the pulsed marker of 0.136 s duration filled by the 15 kHz sinusoidal signal (Figure 5d) which is necessary for ground-based equipment to synchronize the hard copy registration device. This marker is used during transmitting of ionograms by the PM modulation telemetry system. Then the 338 pulses from 0.3 up to 15.95 MHz are emitted with the 17.07 ms period. At the end of the ionogram the pulsed marker is formed, filled by the sinusoidal 10 kHz signal. The detailed structure of the video signal between the neighborhood frequencies is shown in Figure 5e. After the previous frequency signal registration, the "0" level is registered during 1.6 ms, then the negative sync of 533 μ s duration is formed for the registration equipment synchronization. At the same time the heterodyne is tuning from one frequency to the next. Then the positive pulse is formed, the duration of which contains information on the natural noise level on the given frequency at the receiver input (the AGC pulse). Then follows the pulse shown by the stroked line which appears on the frequencies multiple to 1 MHz (the frequency mark). Every 5 MHz the frequency mark appears not only on the frequency multiple to 5 MHz, but on the next frequency too (the double mark). Then the negative "zero height" pulse is generated by 13 μ s duration and the positive 133 μ s duration pulse coincides with the pulse of the sounder transmitter. Then the receiver output waveform is registered contained in the reflections from ionosphere, natural and artificial noises.

2.4 IS-338 ionogram format

The presence of telemetry systems of two types onboard satellites (Figure 2) gave a possibility to vary the type of transmitted information and the duration of sounding periods. The

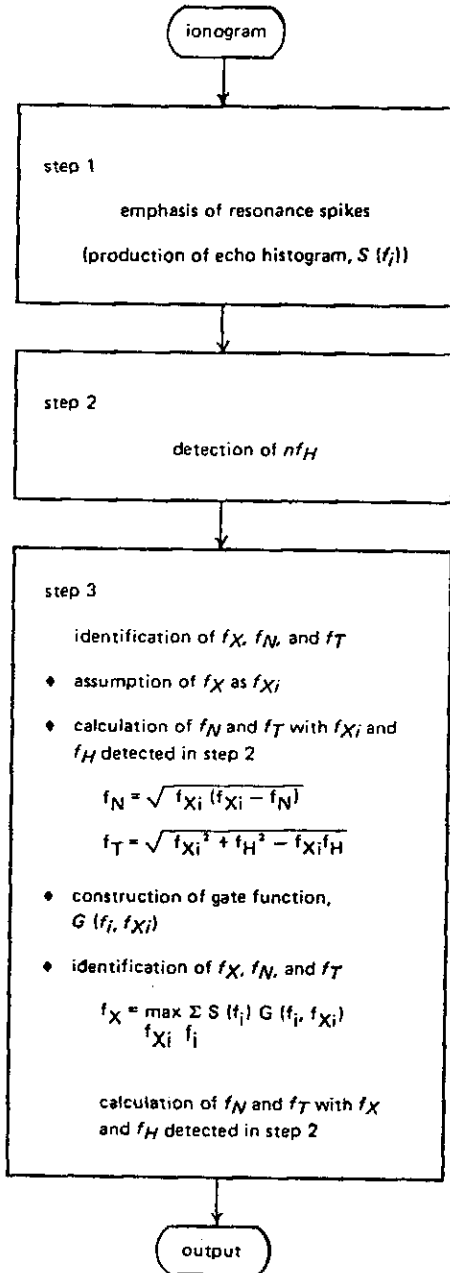

Figure 2. Flow chart for automatic resonance spike identification.

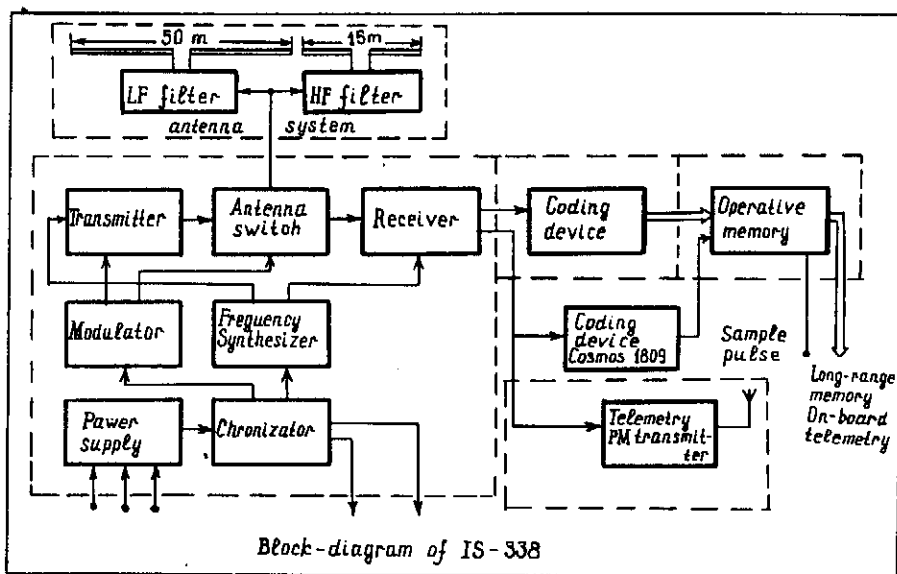

Figure 3. Block diagram of IS-338.

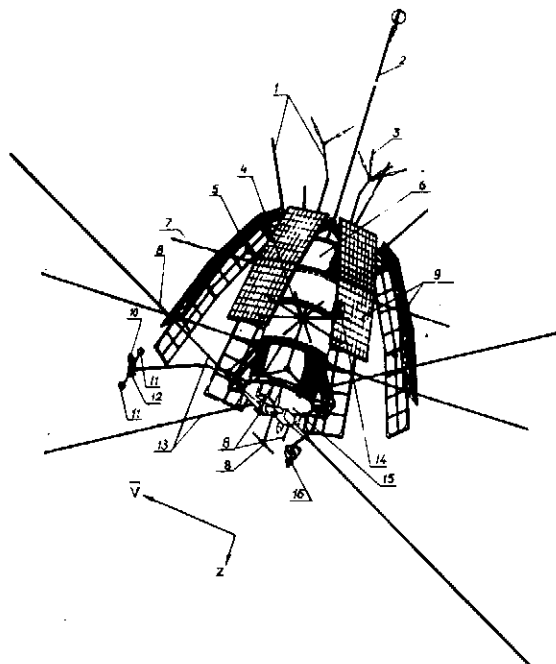

Figure 4. Intercosmos-19 satellite. 1 - command radio line antennas; 2 - gravitation-damping device; 3,4 - antennas of PM and wideband FM telemetry, 5 - P-4 probe; 6 - service equipment module, 7 - radiospectrometer antenna; 9 - solar cell panels; 10 - KM-3 probe; 11 - VLF electric probe; 12 - VLF magnetic probe; 13 - IS-338 antenna system; 14 - soft-particle spectrometer; 15 - module of scientific devices; 16 - high-capacity telemetry system antenna.

ionogram transmitted by analogous PM VHF telemetry system in the 136-138 MHz frequency band is presented in Figure 6a. The full complex video output shown in Figure 5 was transmitted but the quantity of ionograms transmitted and the range of latitudes and longitudes was limited by the direct visibility of the satellite by the ground-based telemetry receiving station. In the direct transmission mode the repetition period of sounding was always equal to 8 s and nearly 70 ionograms in average were registered during one pass of the satellite over the telemetry station.

The digital ionogram format is shown in Figure 6b. Ionograms of this type are obtained with the help of a coding device and operative memory, then they are copied to the onboard telemetry memory. Depending on the ionogram repetition period (8, 16, 32, 64 s) the geographical scope changed. When the repetition period was 64 s, it was possible to put in memory nearly 10 or 11 full revolutions which corresponds to nearly 250° in longitude. In this format only three points were registered on every frequency. These points corresponded to time delays of the first three pulsed signals exceeding the threshold determined by the AGC. The delay time was transformed to 8-bit numbers with the sample frequency of 15 kHz which corresponds to 10 km in apparent range scale. If any signal on a given frequency did not exceed the threshold, the number corresponding to 2000 km delay was generated. The two numbers equal "3" and two numbers equal "6" were the marks of beginning and the end of the ionogram. The volume of the ionogram was 1014 bytes. The details such as plasma resonances were lost during this type of registration but the global survey during the short period of time was the prize.

For the Cosmos-1809 satellite the new type of coding was developed by Dr. M. D. Fligel and Dr. G. V. Vasiliyev. It was named digital-analogous ionogram and is shown in Figure 6c. The additional coding device and operative memory were installed onboard the satellite (Figure 3). As in the previous format, the sampling frequency was 15 kHz, which corresponds to 10 km in apparent range. If the output signal within the 10 km apparent stretch was higher than the threshold level the logical "1" was generated, otherwise the logical "0". So for the one definite frequency the apparent range 0 - 2000 km contained 200 bits of information. These 200 bits were divided into 25 groups of 8 bits -- the 25 quasi-byte numbers stored in the operative intermediate memory. These 25 bytes were supplemented by 3 bytes more, two of which contained information on the 16-level AGC voltage and the third one the frequency mark. As a result, one ionogram contained $338.28 \approx 9.5$ bytes. To mark the beginning and the end of the ionogram nearly 256 numbers were recorded containing only "1". The onboard memory gave a possibility to store nearly 250 ionograms. Taking into account the ionogram repetition period of 32 s and the satellite orbit period of 104 min, the ≈ 1.3 of satellite orbit were stored, which was close to the ISS-B regime with the exception that on the Cosmos-1809 satellite the sampling of ionograms was two times more often.

2.5 Future topside sounders

One of the advanced suggestions was made by Mathwich et al. [1981] where all ideas of ground-based digisondes were included. Up to now this project is not realized. It seems that it would be useful to remind readers the main ideas of the paper.

The fundamental problem of topside sounding is automatic scaling of obtained ionograms to exclude operator intervention. The very important steps in this direction were made in the suggestion. These are the coherent signal processing by special signal coding and tagging of the right-hand circulated mode and left-hand circulated mode by combination of special antenna systems, separate emission of right-hand circulated pulses (RCP) and left-hand circulated pulses (LCP), and using different codes for RCP and LCP. Great attention was paid to the extensive onboard data compression. The second important feature of the suggested mission is the decreasing the power to 30 W of emitted pulses. As was shown by Pulinets and Selegey [1983, 1986] the large-scale modification of near satellite plasma takes place during and after emitting of

Table 3

THE IS-338 TOPSIDE SOUNDER PARAMETERS

Number of frequencies	338
Frequency range	0.3 - 15.95 MHz
Crystal synthesizer range	35.3 - 54.95 MHz
Frequency step	25 kHz in 0.3 - 1.5 MHz range 50 kHz in 1.5 - 15.95 MHz range
Synthesizer switching time	- 2 ms
Emitted pulse duration	133 μ s
Repetition rate	58.6 Hz
Ionogram duration	6.04 s
Ionogram repetition period	8, 16, 32 or 64 s (depending on telemetry memory mode)
Apparent height range	0 - 2000 km
Height resolution	10 km
Receiver sensitivity	5-10 μ V with S/N=3
Receiver IF band width	12 kHz
Dynamics	80 dB
Supplied power	50 W during sounding 0.2 W during pauses
Pulsed emitted power	200 - 300 W
On every 338 frequencies one pulse was emitted	

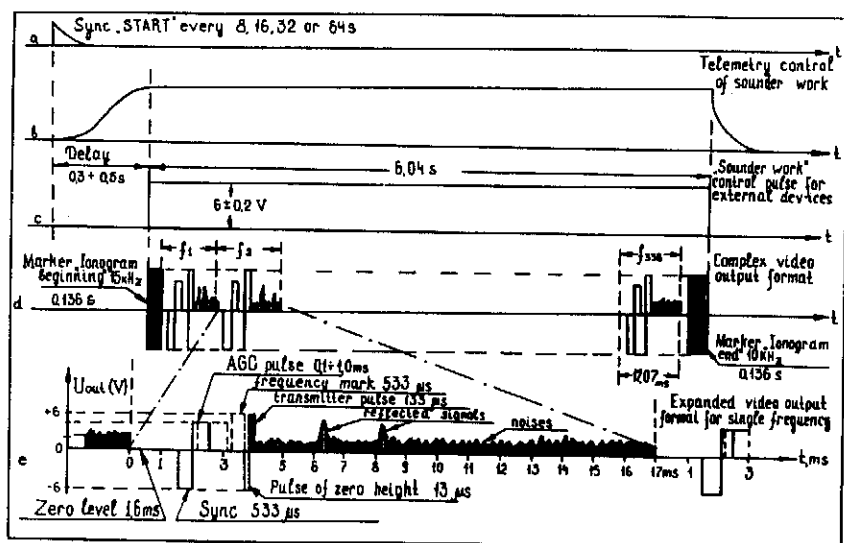

Figure 5. Video output and timeframe of the IS-338 sounder.

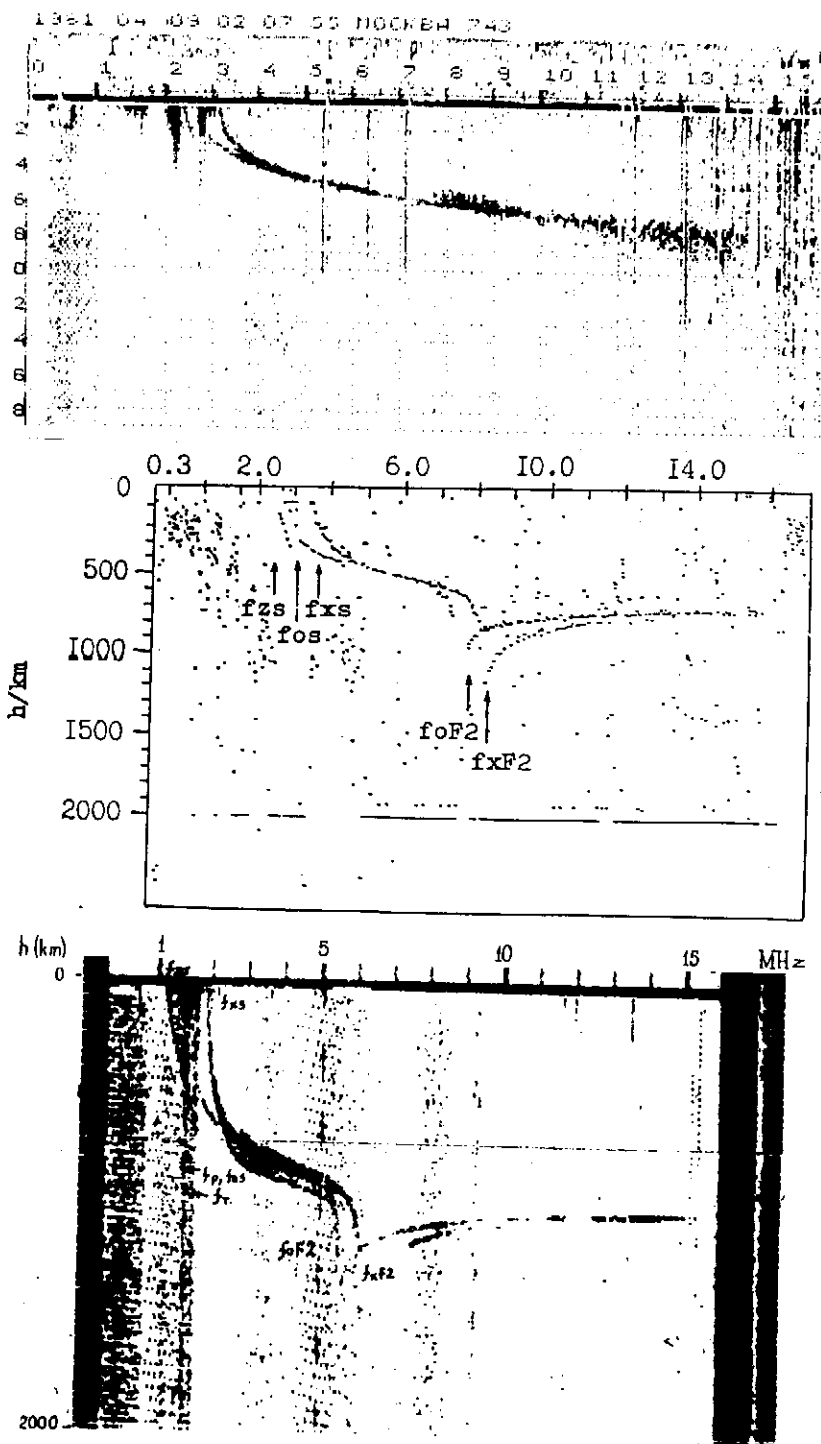

Figure 6. Different IS-338 ionogram formats.

powerful RF pulses of the sounder transmitter. It creates problems for different kinds of in situ onboard measurements as from the point of view of real values of measured parameters of undisturbed plasma so from the point of view of simple electronic interference. The diminishing of the emitted power by the order is a great step to the last concept of the mission as a guest mission on any spacecraft having the appropriate orbit. The questionable feature of the mission is the duration of ionogram sampling (to 40 s). In highly dynamical auroral and polar regions it may create problems in ionogram interpretation, and many details of the morphological structures of the high latitude ionosphere might not be resolved.

3. The Global Mapping of the Topside Ionosphere

It is hoped that such projects as WITS and SUNDIAL as future parts of the STEP Project are manifestations of a renaissance in ionospheric science. One of the main purposes of the SUNDIAL project, for example, is to know "the ionospheric state at any place, at any time and under any conditions" [Szuszczewicz et al., 1988]. Global mapping of the ionosphere with the help of satellite topside sounders gives such a possibility. But to not fall in euphoria it is necessary to realize all difficulties and limitations of the technique. Topside sounding is one of the most complex techniques of remote sensing from the points of view of

- a - the great variability of ionospheric parameters
- b - interpretation of ionograms (propagational problems, oblique layers, ducting, spread echoes, etc.)
- c - scaling of ionograms
- d - four-dimensional representation of the results of sounding.

3.1 From ionogram to map

The problems of topside ionogram scaling and vertical profile calculations were sufficiently discussed [Hagg et al., 1969; Jackson, 1969; Huang and Reinisch, 1982; Reinisch and Huang, 1982; Serebryakova, 1986; Sotsky, 1986] and it seems it is not necessary to discuss them in this paper. I'd like to discuss only one of the problems of ionogram interpretation: the role of the trace of the Earth's reflection echoes. If we assume vertical propagation and horizontal layered structure of the ionosphere, the critical frequencies scaled from the topside reflection trace (TRT) and the Earth's reflection trace (ERT) have to coincide (Figure 7a). In practice, however, we observed many cases where the traces did not coincide as in Figure 7b (too short) or Figure 7c (overlapping). In the case of Figure 7b we deal with the very thick F layer [Kochenova and Fligel, 1989] which can lead to errors in the determination of the F peak height. The case of Figure 7c is connected with oblique propagation of sounder pulses due to the nonhorizontal position of the F layer [Fligel, 1989]. Figure 8 explains this situation. The height scaled from TRT does not give real height values but $h \cdot \cos \alpha$ (α is the angle which the F layer makes with horizontal). On the other hand, the ERT gives the real value of the critical frequency f_{oc} due to the vertical propagation of ERT pulses. But the observed Earth reflections do not reach this value screened by the oblique F layer. The last observed point of ERT is close to $f'_{oe} \approx f_{oc} \cdot \sec \alpha$. In the cases of Figures 7b and 7c the ERT is a representative trace for the accurate topside profile calculation [Kovalev et al., 1989].

The next step is to combine the obtained set of profiles to represent the global distribution of electron density. Two techniques were used: vertical cross sections of the ionosphere during one satellite revolution over the Earth or the plane distribution of one of the ionospheric parameters (f_oF_2 distribution, for example) versus geographical or geomagnetical coordinates. In the first case we have a snapshot of the state of the ionosphere [Vasiliyev et al., 1981]. On Figure 9 the global distribution of electron density is shown for the different latitudes but for some fixed longitude determined by the satellite orbit plane position.

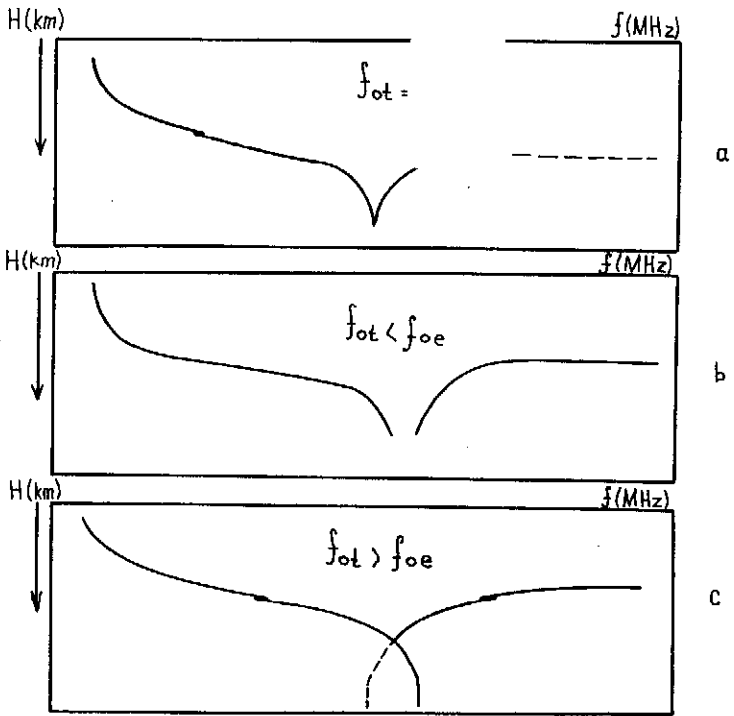

Figure 7. Different cases of topside and ground-reflected traces.

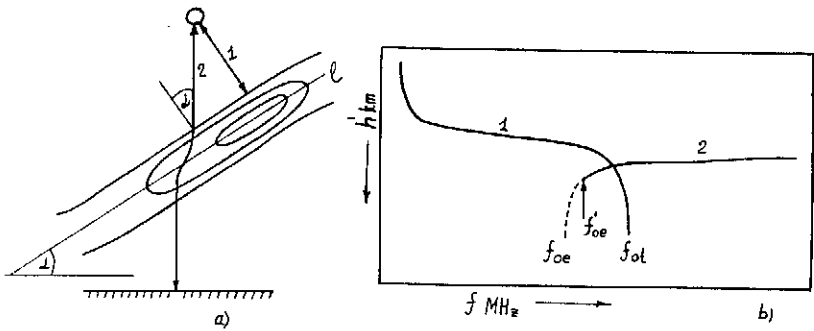

Figure 8. Overlapping on topside ionograms.

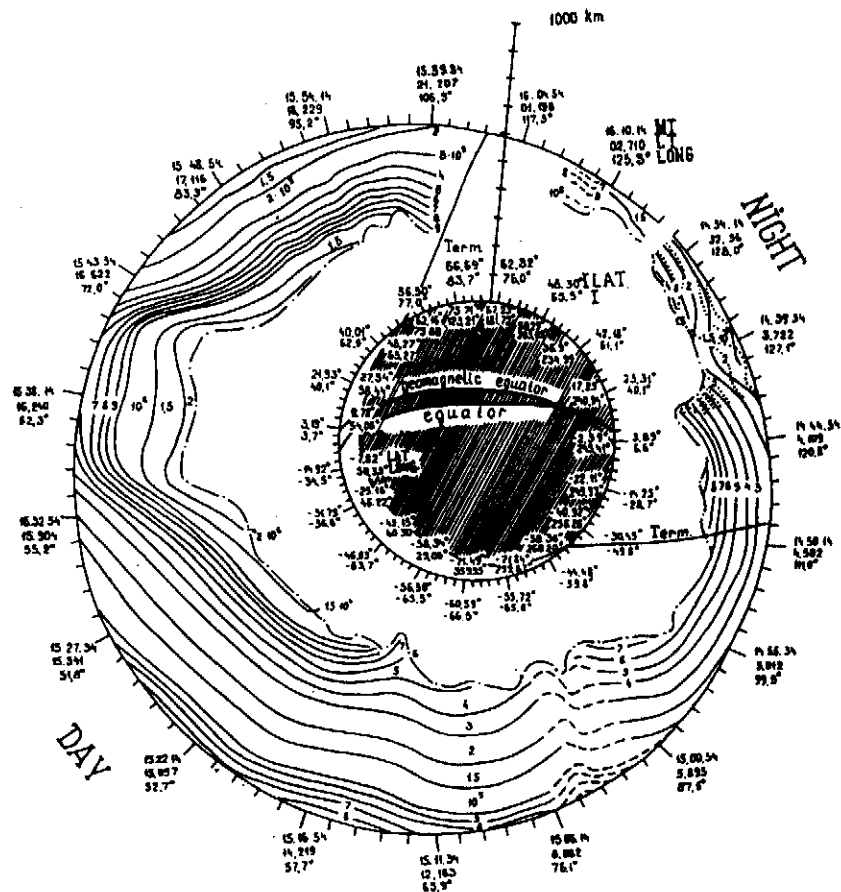

Figure 9. Global distribution of electron density for one satellite orbit.

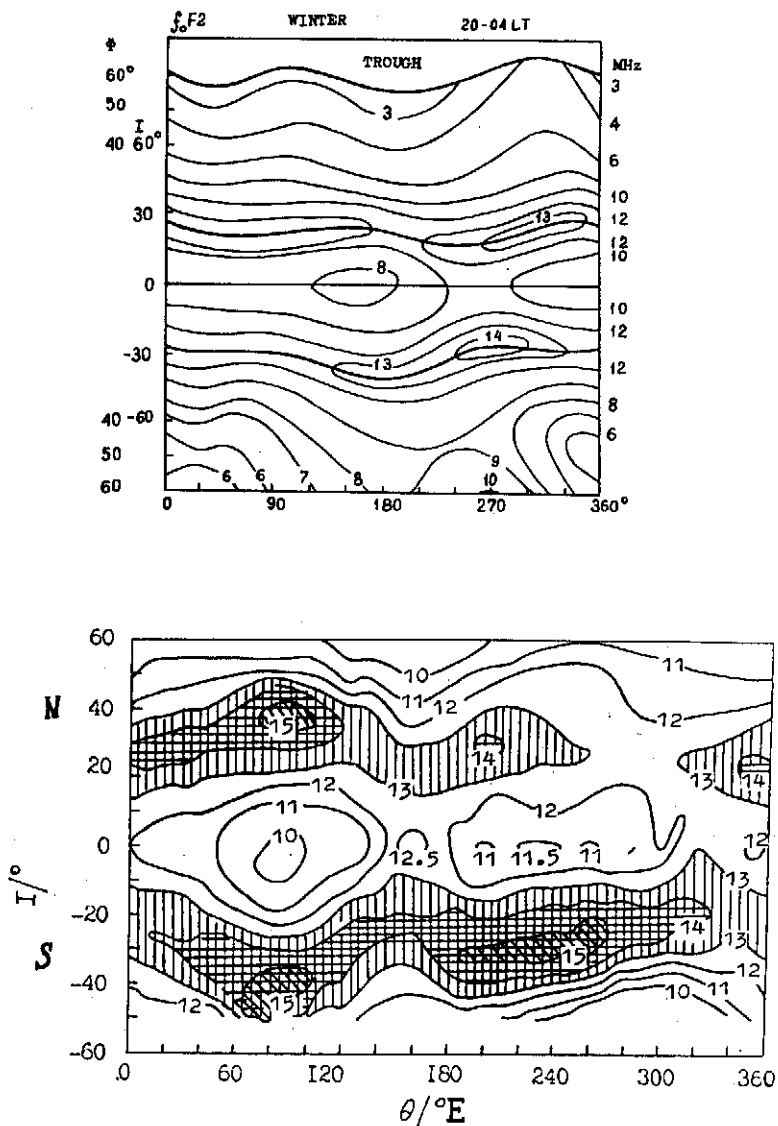

Figure 10. LT-maps for f_oF_2 solar maximum (1979-81). a) winter nighttime conditions; b) summer daytime conditions.

The most difficult step is the transition from single orbit data to real maps. The shift in longitude during one full revolution of the satellite with orbital period of order of 100 min, taking into account Earth's rotation velocity, use to be near 25° . So it is necessary to have more than 14 full revolutions to scan over all 360° of longitude which equals 24 hours of continuous sounding. Here one more problem arises: the problem of LT and UT maps. The satellite on the near polar orbit is "tied" to the definite local time. This means that the fixed latitude the satellite crosses at the same local time. The satellite orbit is divided by two parts with 12 hours difference in local time, each part "tied" to its local time. So using information collected during 24 hours it is possible to build two global maps for two fixed meanings of the local time, so-called LT-maps. But one must conceive clearly that an LT-map is in some sense the artificial formation (situation with the same local time all over the world is physically impossible). These maps show how the ionospheric parameters differ at the same local time on different longitudes. It is a very convenient technique to build such maps for studying the global longitudinal effect [Diominov and Karpachov, 1986; Karpachov, 1987; Diominov et al., 1987; Ben'kova et al., 1988]. Two such maps for night and for day conditions are shown in Figure 10.

Another global representation is the so-called UT-map. It represents the real state of the ionosphere at a given moment of UT, its "instant picture". It is evident that having the satellite "tied" to the local time it is impossible in principle to obtain this kind of map for a short period of time. Let us try to estimate how many times it is necessary for a satellite like IK-19 to look over the whole 24 hours of LT and UT. For the IK-19 satellite the diurnal time shift in local time was nearly 12 min. In this case nearly 4 months is necessary for the whole survey in local time. If we take into account the ascending and descending parts of orbit it is possible to double shorten this interval, but in reality a satellite does not work continuously. It is connected with the problems of satellite management: refreshing of onboard memory, sending of steering commands and programs and so on, and all the same the building of UT-maps takes more time than a season. In fact the building up of one UT-map is equal to building up a whole set of LT-maps for 24 hours. The UT-map will reflect the real ionospheric situation only when the period of building up corresponds to the same season. It is clear also that the data must be selected in solar and geomagnetic activity. In the case of solar maximum these conditions to a great extent restrict the range of suitable material. So even for one instant of UT the task of building a global map is very complex. To build a really good UT-map it is necessary sometimes to take data from different years of satellite operation for the same season. We don't speak yet on the equipment restrictions onboard the satellite. For example, the Japanese satellite ISS-B, due to the small volume of onboard memory, could receive information only from 3 - 4 orbits a day. This fact makes it impossible to build adequate UT-maps on the basis of these data.

One of the advantages of IK-19 was a large-memory regime when information was collected from 10 - 11 orbits without a break (one ionogram every 64 s), which constitute 17 hours of sampling and 250 degrees in longitude. In addition, this mode of operation, after a small break, could be repeated. This permitted to build up the LT-map for the short period of time of nearly two days. These maps have some shortcomings connected with the incomplete polar orbit of the satellite. The change in local time along the orbit with 74° inclination within 60° interval was sufficiently large ($\Delta LT \approx 4$ h). This difference is more noticeable if we work in magnetic coordinates. For example, for fixed geomagnetic latitude $60^\circ\Phi$ in the Southern Hemisphere $\Delta LT \approx 2$ h. Although the quantity of selected data must be increased before we could prove that this change doesn't matter for our specific problem. We analyzed this question and at least two problems could be solved without narrowing of the LT interval: the strong disturbances in the upper ionosphere and studying of global longitude effect in the midnight ionosphere. It is due to the fact that the observed variations are essentially larger than the temporal variations.

So what to do with the mapping problem? It is evident that in the frame of one satellite the problem of LT-UT maps cannot be solved. Some improvement could be reached only by the continuous transmitting of information to the Earth without putting it into memory. The retranslation geostationary satellite is a means of decision. But the problem of 2-4 months for UT maps remains. To shorten the period a system of satellites is necessary.

3.2 The proposed satellite system of global monitoring and mapping of the ionosphere

As we realized from the previous paragraph, for proper monitoring and mapping from satellites, two main demands should be fulfilled: continuous sounding and sufficiently fast overlapping of 24 hours of LT time. For the first, different approaches could be used. The simplest one is high capacity onboard memory (nearly 24 hours) like on the Interkosmos-19 satellite. For mapping it is acceptable, but for operative monitoring it is a wrong decision due to the delay in receiving data. The possible solution is to have only one-orbit memory like on the ISS-B satellite and to transmit information after every pass. But it is a difficult task: too much effort is necessary for satellite control, and several receiving stations spread in longitude should be used, due to the fact that one receiving station can receive only four orbits per day, owing to shift of the satellite orbit along longitude. The utilization of a geostationary satellite as a retranslator arises. Several variants are possible. First is a direct continuous transmission from the sounding satellite to the geostationary satellite without any remembering. It is a good suggestion but it needs a sophisticated antenna system to track the retranslator by the moving satellite. The intermediate variant is possible: to transmit to the geostationary retranslator the information remembered every revolution.

The second problem of mapping and monitoring is coverage of different LT to build the real UT-maps. Unfortunately, only an expensive way is possible -- using several satellites which are put on orbits shifted one from another at definite intervals of LT. For the first time this task was set by Mathwich et al. [1981]. It seems that four satellites would be sufficient for any sophisticated task of monitoring, modeling, and so on. The problem is how to arrange them, what local times are decisive for the state of the ionosphere. The different arguments could be put forward: the midnight - noon sector, the dusk - dawn sector, etc. Every period of time has its own influence on the ionosphere. The way out lies, as it seems, not in the selecting of definite LT sectors, but in refusion from strict sun - synchronized polar orbits. The 80 - 85° inclination orbits shift during a day on 8 - 12 minutes. Such shift gives a possibility to cover all LT sectors during approximately two weeks. The schematic representation of the proposed system of ionospheric monitoring is shown in Figure 11.

Naturally, topside sounding does not exist in isolation from other sounding techniques and a systematic approach should be used in ionospheric service. This problem was raised by Danilkin [1987a] where cooperation of different radio means is discussed (see Figure 12). The use of different sources of ionospheric information permits to make more profound reconstruction of the F region [Gulyaeva, 1988]. Use of radio beacons onboard the satellites permits to build computer-aided 3-dimensional tomography pictures of the ionosphere [Austen et al., 1988].

4. Nontraditional Techniques in Topside Sounding

The standard work connected with evaluation of height-frequency-density characteristics of the ionosphere are always accompanied by attempts to extract more information. As an example, the studying of topside plasma resonances could be given [Benson, 1982; Oya, 1970, 1971]. We will try to discuss only such techniques which give a possibility of global monitoring of some ionospheric parameter or improve the topside sounding technique itself.

As a first attempt, Benson's [1972] paper could be considered. The global distribution of different kinds of plasma resonance were studied, many interesting irregularities were discovered,

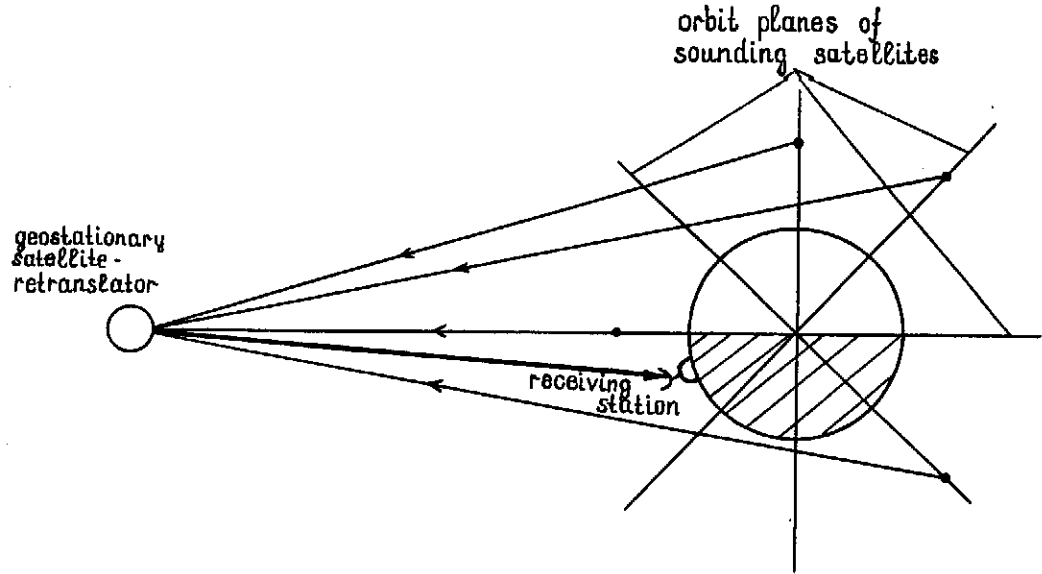

Figure 11. Satellite system for global monitoring of the ionosphere.

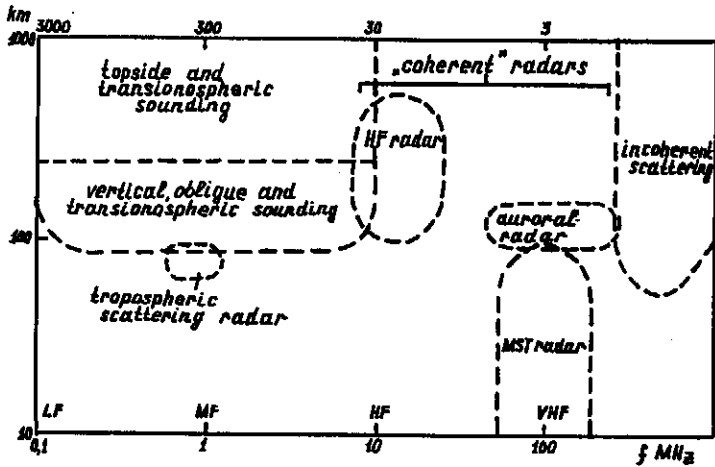

Figure 12. Systematic approach to ionospheric sounding.

but this work has not received further development, primarily due to the problem of resonance scaling. Automatic scaling [Igi and Aikyo, 1986] has not been developed.

4.1 The DNT resonance as an indicator of small-scale irregularities in the ionosphere

As has been shown by Denisenko et al. [1987] and Bratsun et al. [1988], the weakening of O-traces on topside ionograms in the frequency band $F_p < f < f_{UHR}$ is connected with the transformation of ordinary waves into slow extraordinary left-hand polarized Z-waves in the presence of small-scale irregularities. As a manifestation of scattering on irregularities of Z-waves the diffuse resonance appears on the topside ionograms (see Figure 13) named by Benson [1982] DNT resonance. It appears between the local plasma frequency f_p and the frequency of upper hybrid resonance f_{UHR} in the case of $f_p > f_{He}$, and between the local gyrofrequency f_{He} and upper hybrid frequency when $f_p < f_{He}$. The apparent height of the resonance appearing on topside ionograms is a mixed value which is a manifestation of its duration and amplitude simultaneously. This height of DNT resonance scaled from ionograms along the satellite orbit may be used for estimating the scale of irregularities development. Figure 14 represents the distribution of the resonance height vs magnetic latitude for four orbits of Cosmos-1809 satellite for day conditions during summer solstice, May - June 1987 [Pulinets et al., 1989]. It could be used to study a global distribution of small-scale irregularities in the upper ionosphere.

4.2 Natural noises

On Figure 14 one can mark the groups of points in the vicinity of the magnetic equator and on latitudes near $+80^\circ$ which are situated at the top of the figure. They manifest that the DNT resonance height exceeds the whole height range of the ionogram. The special experiment was conducted onboard the "Sibir" icebreaker where the receiving station was installed during its voyage to the North Pole in summer 1987. The task of the experiment was to check if the noises are stimulated by the sounder transmitter [Danilkin and Pulinets, 1989]. The transmitter was switched off and the two consecutive ionograms with intervals of 8 s are presented in Figure 15. It is evident that after switching off the transmitter the noises did not disappear, so they indicate the turbulent region of the high-latitude ionosphere where they are generated naturally, primarily due to particle precipitation. So the monitoring of wide-band noises in the DNT resonance frequency band gives a possibility to make a diagnosis of the state of the ionosphere. This technique is in the very beginning but the hope exists that it will be very useful.

The natural noises may be useful, not only in the DNT frequency band but in the wide range of frequencies. For this purpose the voltage of the AGC is used which is measured before the ionosonde transmitter pulse. Following the registered intensity level along the satellite orbit, many ionospheric properties can be observed. One can see the different ionospheric structures fitted by the upper hybrid resonance cutoff (Figure 16). The increasing of intensity in the whistler frequency range, as well as in the upper-hybrid range, in the polar region confirm electron precipitation as the source of HF emission in that area. The envelope of signals from ground-based broadcasting transmitters indicate the changes in f_oF2 frequency. The form and position of the main trough within the F-layer maximum could be determined. In some sense this representation is more rich than the $N(h)$ profiles because it gives information not only on the electron density, but on a lot of physical processes taking place in the ionosphere. So measurement of natural noises is an additional means of topside sounding [Pulinets et al., 1988].

4.3 Galactic noise as a source of local density estimation

In the frequency range between the local upper hybrid frequency f_{UHR} and critical frequency f_oF2 , the principal source of natural radio noise is galactic. If the sensitivity of the sounder receiver is sufficient enough to register them, it is possible to use the low frequency cutoff

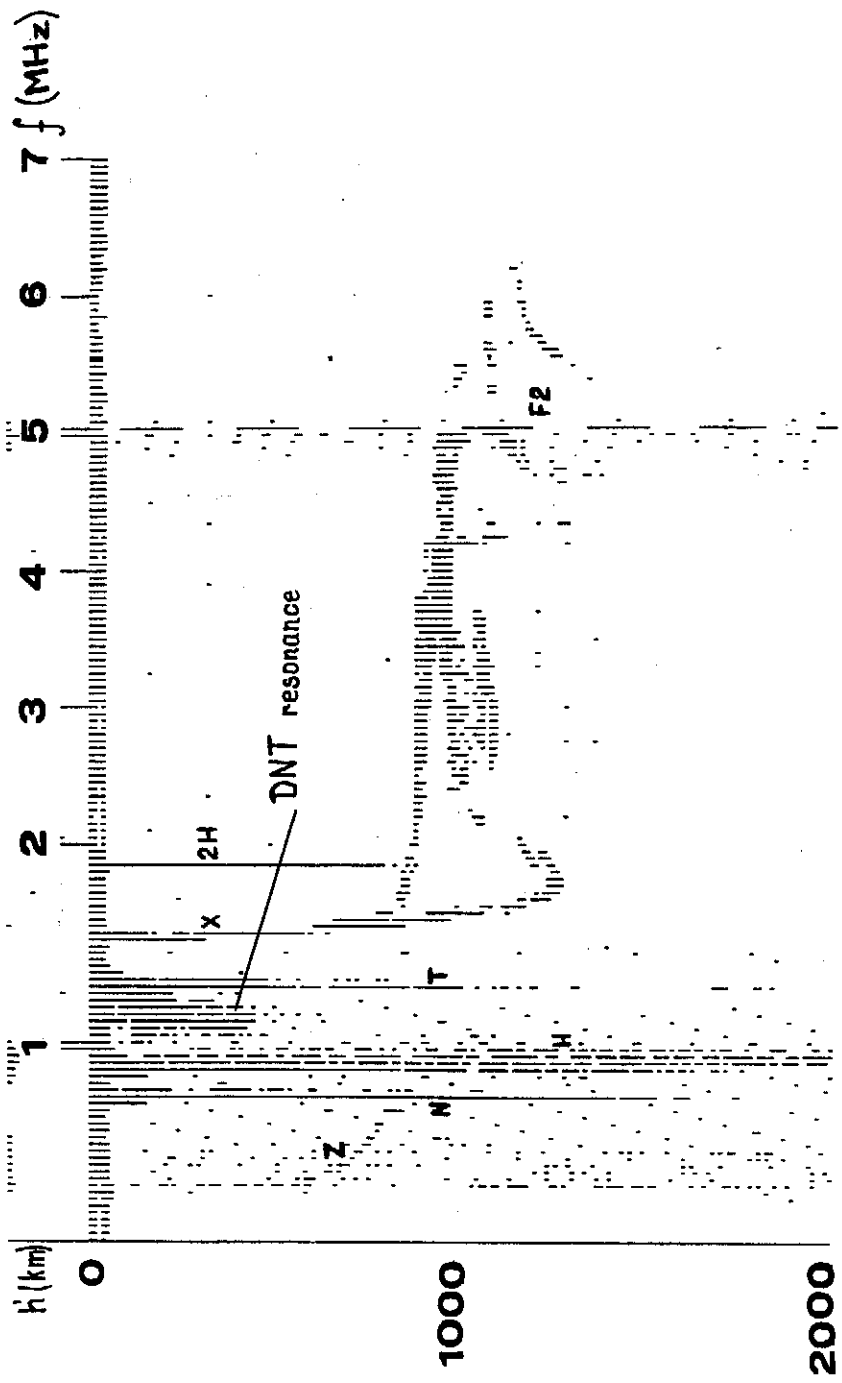

Figure 13. DNT resonance on the topside ionogram.

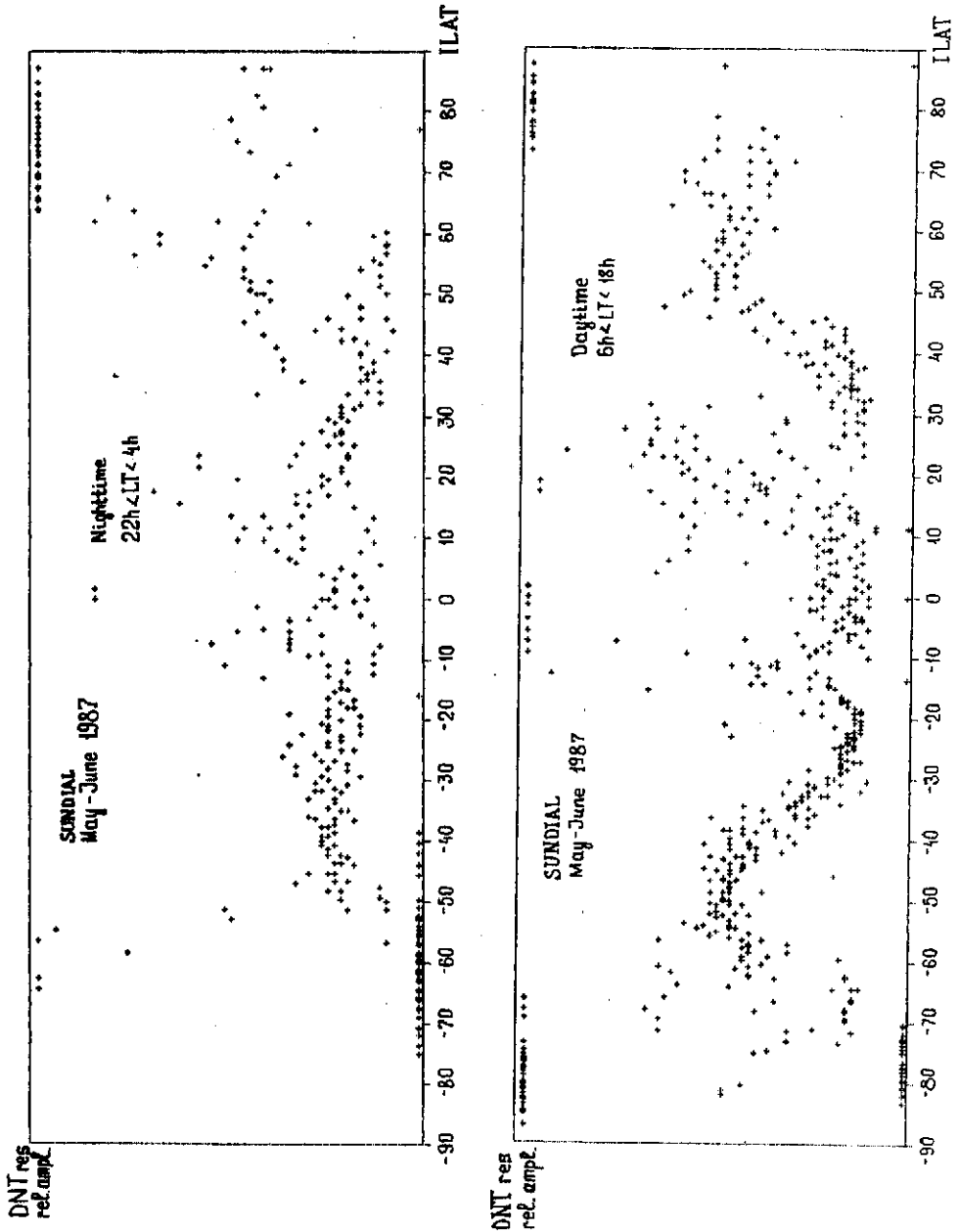

Figure 14. Global distribution of DNT resonance amplitude.

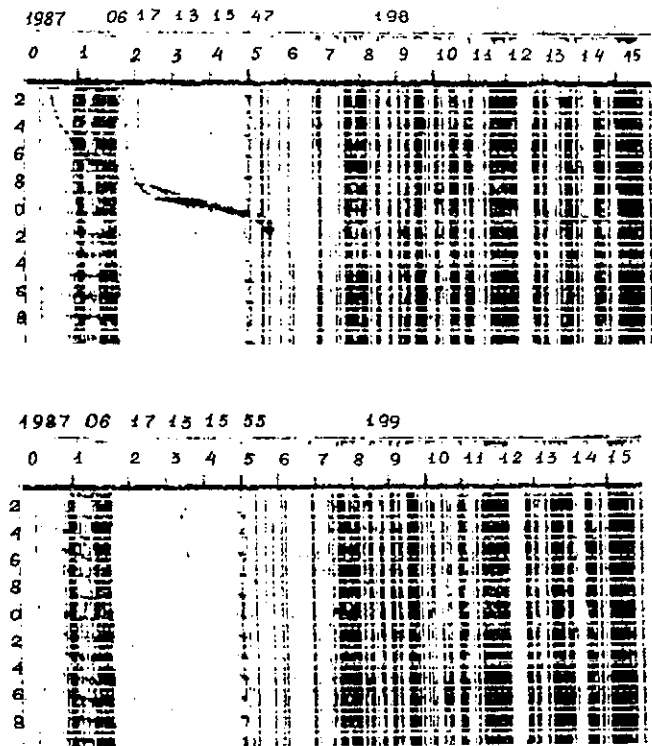

Figure 15. Switching off of sounder transmitter over the north polar cap.

COSMOS-1809 R: 735 DATE: 09-02-1987 UT 09:47:33

H: 960-995 km

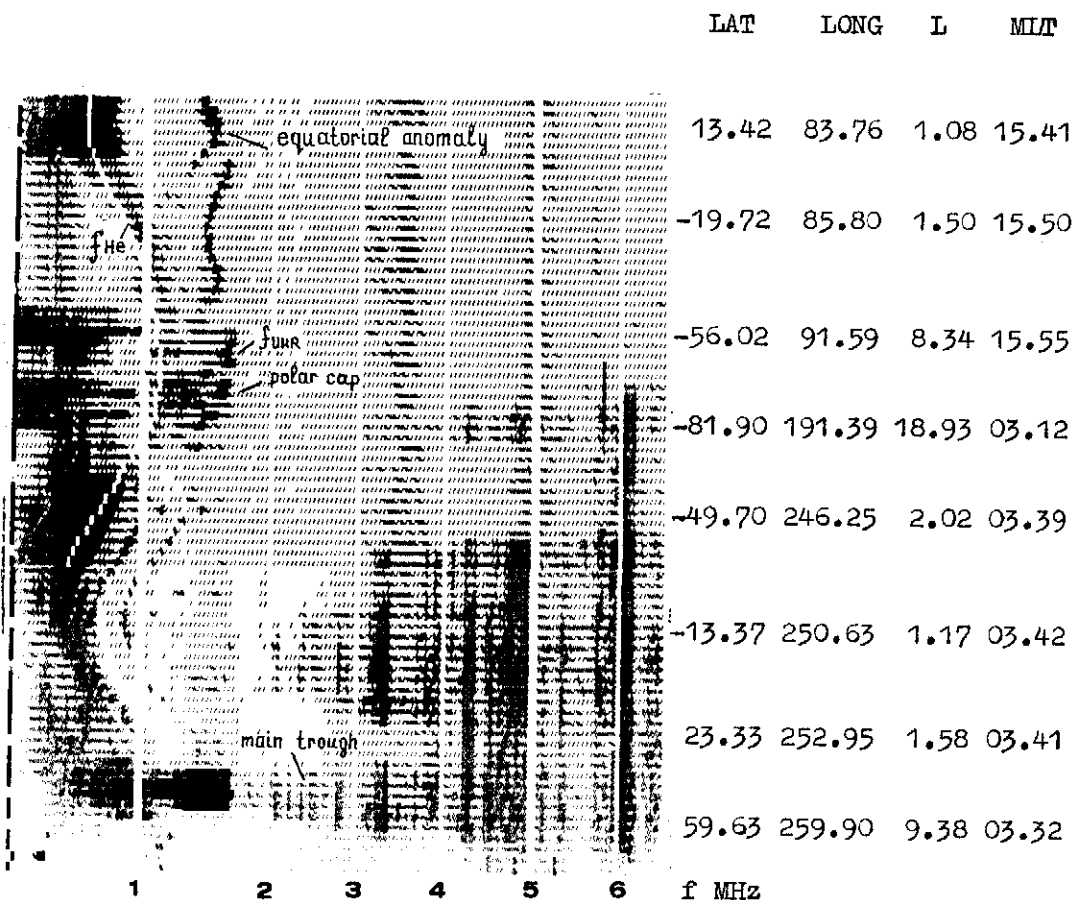

Figure 16. AGC dynamic spectra from COSMOS-1809 data.

of the galactic noise to estimate the local upper hybrid frequency, which was suggested by designers of the ISS-B satellite [Summary plots..., 1983]. In the ionosphere above the F-layer peak, there is a cone of directions within which an extraterrestrial noise can reach the satellite. The cone is narrower on the lower frequencies and the AGU level which integrates over the whole cone becomes lower on lower frequencies. The scaling of the cutoff frequency f_{CNO} gives estimation value for local plasma frequency. It is shown in Figure 17 a good correlation between the frequencies which is better than correlation between f_{CNO} and f_{UHR} and between f_{CNO} and f_x , nevertheless that f_{CNO} is always higher than f_{UHR} and distributed near the f_x cutoff. Naturally this technique could be used when the different kinds of interference are absent and the local density is higher or of order of local gyrofrequency.

4.4 Transionospheric sounding

The topside sounder data do not contain information on the internal ionosphere which determines the conditions for RF signal propagation. The technique of transionospheric sounding gives a possibility to accomplish the topside sounding information by using the frequency band close to the critical frequency f_oF2 . The method was proposed first by Danilkin [1985, 1987b]. The main idea of the technique is to record the time delays of sounder pulses on frequencies, not only in the frequency band lower than the critical frequency f_oF2 , but on the higher frequencies also. The higher frequency signals go through the bulk of the ionosphere and are named "transionospheric" signals. It is necessary to have ground-based equipment synchronized with the topside sounder sweep. The synchronizing signals may be transmitted by the additional line not so affected by ionospheric layers, for example on frequencies higher than 100 MHz. Two almost equivalent methods are used [Danilkin, 1987b]: registration of the sounder transmitter signals on frequencies higher than f_oF2 by synchronized ground-based transmitter signals by the topside sounder receiver (Figure 18b) -- reverse transionospheric sounding (RTIS). These methods give cross sections of the ionosphere within 5000 km radius. The total oblique profiles could be calculated. The problem comes in determining the function of the electron concentration from the equation

$$p' = E^{\text{sat}} \mu'(\psi) ds = E^{\text{sat}} \mu'(\psi) \cos \alpha(\psi) ds$$

where sat and E are the coordinates of the satellite and ground-based station, respectively:

$$\psi = [t, f_H \theta(S), \varphi_N(S)]$$

μ' is the group refraction index, f_H the electron gyrofrequency, f the wave frequency, θ angle between the local vertical and geomagnetic field, α angle between the wave and ray normals.

The method gives a possibility to determine accurately the maximum used frequencies (MUF), to estimate the horizontal gradients of electron concentration. One of the possible applications of the method is the diagnosis of ionospheric irregularities schematically shown in Figure 19. The bays shown on transionograms 1 and 2 between frequencies f_1 and f_2 manifest the presence of irregularities between ray traces of the waves with these frequencies. But if we take only one ionogram for position of satellite 1 the ambiguity exists on the position of the irregularity (the upper or lower ionosphere). But comparing with position number 2 decides the problem. The difference between frequencies f_1 and f_2 determines the irregularity dimension and the $\Delta D'$ shown on transionograms determines the deviation of concentration $\pm \Delta N$ in the irregularity.

5. Conclusion

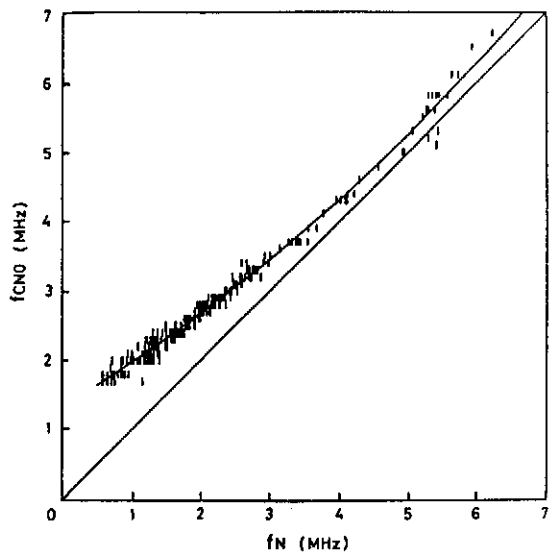

Figure 17. Empirical relationship between f_n and f_{CNO} .

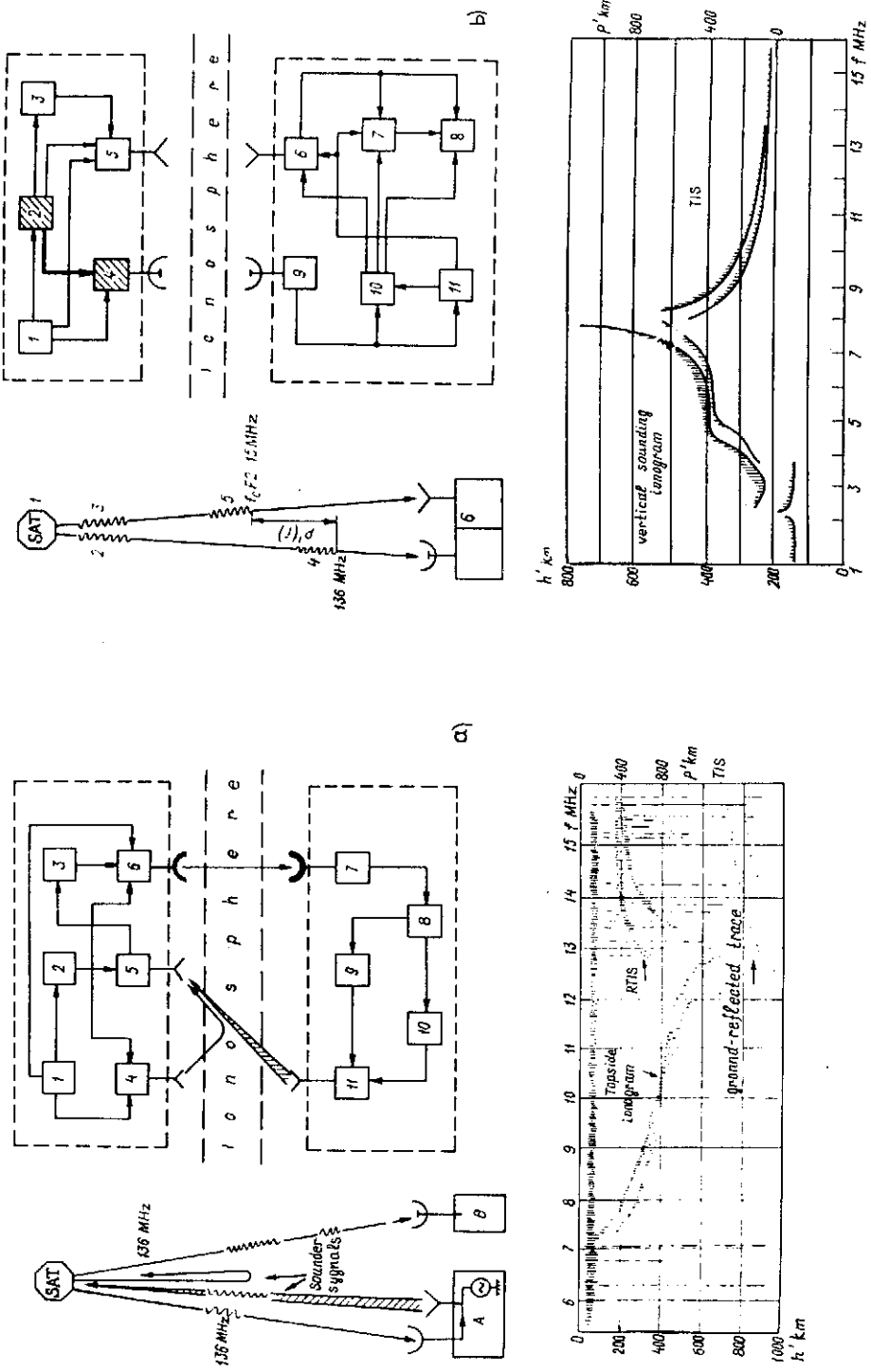

Figure 18. Chart diagrams of a) transionospheric (TIS) and b) reverse transionospheric (RTIS) sounding.

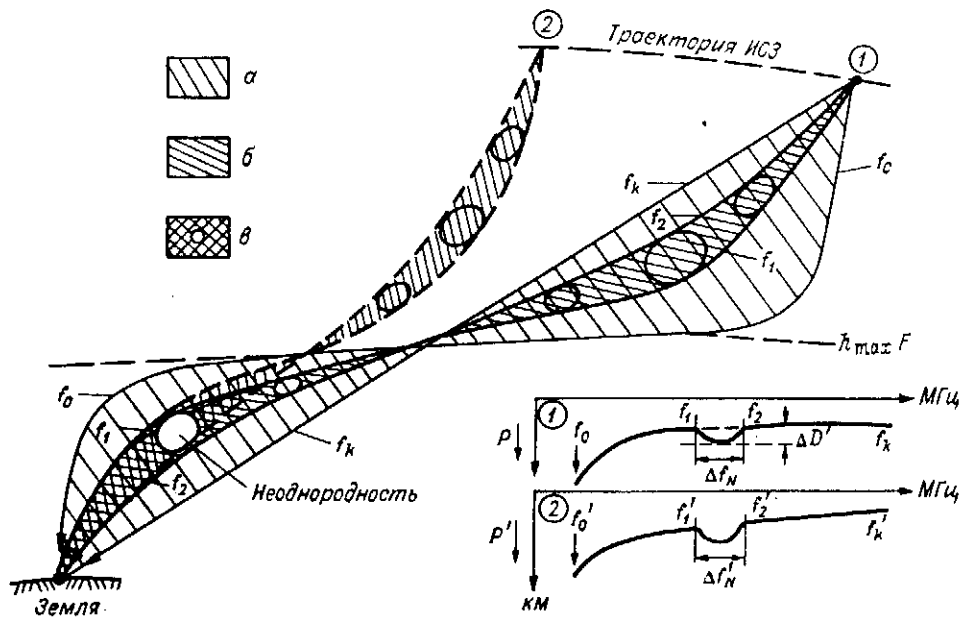

Figure 19. Diagnostics of ionospheric irregularities by transionospheric sounding.

Only the simple mention of the problems and new techniques in topside sounding took a lot of space. What are the key problems for complete knowledge of the ionosphere with the help of the method? I'll try to summarize them.

1. The development of $N(h)$ profile calculation methods with correction taking into account the traces of signals reflected from the Earth and process of F-layer formation.
2. Development of the onboard processing techniques.
3. Creation of a multisatellite system of global monitoring of the ionosphere.
4. Accomplishment of the topside sounding by additional closely related techniques such as use of information on the natural noises and plasma resonances, transionospheric sounding.
5. More wide use of topside sounder data for ionospheric modeling and forecast and creating more sophisticated global ionospheric models.

6. References

- Austen, J. R., S. J. Franke, and C. H. Liu, Ionospheric imaging using computerized tomography, *Radio Sci.*, 23, 299, 1988.
- Atlas of Ionospheric Critical Frequency (f_oF_2) obtained from Ionospheric Sounding Satellite-b Observation*, issued by Radio Research Laboratory Ministry of Posts and Telecommunications, Japan, 1979.
- Benson, R. F., Ionospheric plasma resonances: time durations vs latitude, altitude and $F_N f_H$, *Planet Space Sci.*, 20, 683, 1972.
- Benson, R. F., Stimulated plasma instability and nonlinear phenomena in the ionosphere, *Radio Sci.*, 17, 1637, 1982.
- Benson, R. F., Auroral kilometric radiation: Wave modes, harmonics, and source region electron density structures, *J. Geophys. Res.*, 90, 2753, 1985.
- Benson, R. F., and W. Calvert, ISIS 1 observation in the source of auroral kilometric radiation, *Geophys. Res. Lett.*, 6, 479, 1979.
- Ben'kova, N. P., M. G. Diominov, A. T. Karpachiov, N. A. Kochenova, Yu. V. Kushnerevsky, V. V. Migulin, S. A. Pulinets, and M. D. Fligel, Longitude features shown by topside sounder data and their importance in ionospheric mapping, *Adv. Space Res., Ionospheric Informatics*, 1988, in press
- Bratsun, D. S., P. F. Denisenko, N. A. Zabolin, S. A. Pulinets, and V. V. Selegey, Peculiarities of the topside ionograms in presence of small-scale irregularities in the ionosphere, Preprint IZMIRAN 44(798), to be published in *Geomagn. Aeron.*, 1988.
- Danilkin, N. P., Radioscopy of the ionosphere on the transparency range border, *Radiotekhnika*, 9, 3, 1985.
- Danilkin, N. P., Systematical sounding -- the basis for ionospheric service building, in *Ionospheric-Magnetospheric Service*, Gidrometeoizdat, Leningrad, 46, 1987a.
- Danilkin, N. P., Transionospheric radio sounding as a means for ionospheric conditions control, in *Ionospheric-Magnetospheric Service*, Gidrometeoizdat, Leningrad, 9, 1987b.
- Danilkin, N. P., and S. A. Pulinets, On the nature of wind-band noises by the topside sounding data in high latitudes, in *Results of the First Scientific Expedition on Atomic Ice-Breaker Sibir in Near-Pole Region, AANII*, Gidrometeoizdat, Leningrad.
- Denisenko, P. F., N. A. Zabolin, S. A. Pulinets, and V. V. Selegey, Transformation of ordinary waves into extraordinary waves according to data from topside sounding of the ionosphere, *Geomagn. Aeron.*, 27, 473, 1987.
- Diominov, M. G., and A. T. Karpachiov, The longitudinal effect in main trough configuration. 1 and 2, *Geomagn. Aeron.*, 26, 63 and 682, 1986.
- Diominov, M. G., A. T. Karpachiov, B. B. Afonin, I. P. Khar'kov, and J. Schmilauer, The longitudinal control of the electron temperature in the subauroral ionosphere, *Geomagn. Aeron.*, 27, 409, 1987.

- Fligel, M. D., On the one possible mechanism of oblique propagation of radio waves in topside ionosphere, *Geomagn. Aeron.*, 29, 71, 1989.
- Franklin, C. A., and M. A. Maclean, The design of swept-frequency topside sounders, *Proc. IEEE*, 57, 897, 1969.
- Gulyaeva, T. L., Global reconstruction of the ionospheric F-region structure, *Ind. J. Radio Space Phys.*, 17, 155, 1988.
- Gurnett, D. A., F. L. Scarf, R. F. Fredricks, and E. J. Smith, The ISEE-1 and 2 plasma wave investigation, *IEEE Geosci. Electr.*, GE-16, 225, 1978.
- Hagg, E. L. E. J. Hewens, and G. L. Nelms, The interpretation of topside sounder ionograms, *Proc. IEEE*, 57, 949, 1969.
- Huang, X., and B. W. Reinisch, Automatic calculation of electron density profiles from digital ionograms. 2. True height inversion of topside ionograms with the profile-fitting method, *Radio Sci.*, 17, 837, 1982.
- Igi, S., and K. Aikyo, Automatic identification of resonance spikes for ionograms obtained by ionospheric sounding satellite-b (ISS-b), *J. Radio Res. Lab.*, 33, 169, 1986.
- Jackson, J. E., The reduction of topside ionograms to electron-density profiles, *Proc. IEEE*, 57, 976, 1969.
- James, H. G., Direction-of-arrival measurements of auroral kilometric radiation and associated ELF data from ISIS 1, *J. Geophys. Res.*, 85, 3367, 1980.
- Karpachiov, A. T., The global longitudinal effect in the nighttime upper ionosphere by the Interkosmos-19 satellite data, Ph.D. Thesis, IZMIRAN, 1987.
- Kochenova, N. A., and M. D. Fligel, On the using of ground-reflected trace on the topside ionograms for more precise N(h)-profile calculation, *Ionospheric Researches*, in press, 1989.
- Kovaliov, V. A., V. V. Sotsky, and M. D. Fligel, Improving of accuracy of determining the N(h) profile by the topside sounding data, paper presented at National conf. on Ionogram Interpretation, Troitsk, June 1989.
- Mathwich, H. R., D. E. Aubert, A. F. Martz, K. Bibl, B. W. Reinisch, and D. Lewis, An advanced mission to map the world-wide topside ionosphere, paper presented at Symp. on the Effects of the Ionosphere on Radio Systems, Naval Res. Lab., Office of Naval Res., and Air Force Geophys. Lab., Alexandria, VA, 1981.
- Muldrew, D. B., Nonvertical propagation and delayed-echo generation observed by the topside sounders, *Proc. IEEE*, 57, 1097, 1969.
- Nishizaki, R., N. Matuura, and A. Takahira, Topside sounder onboard ISS-b, *Rev. Radio Res. Labs.*, 28, 155, 1982.
- Oya, H., Sequence of diffuse plasma resonances observed on Alouette 2 ionograms, *J. Geophys. Res.*, 75, 4279, 1970.
- Oya, H., Verification of theory on weak turbulence relating to the sequence of diffuse plasma resonances in space, *Phys. Fluids*, 14, 2487, 1971.
- Oya, H., A. Morioka, and T. Obara, Leaked AKR and terrestrial hectometric radiations discovered by the plasma wave and planetary plasma sounder experiments onboard the Ohzora (EXOS-C) satellite - Instrumentation and observation results of plasma wave phenomena, *J. Geomagn. Geoelectr.*, 37, 237, 1985.
- Pulinets, S. A., P. F. Denisenko, N. A. Zabolotin, and T. A. Klimanova, New method for small-scale irregularities diagnostics from topside sounder data, paper presented at SUNDIAL Workshop, McLean, VA, May 1989.
- Pulinets, S. A., A. Kiraga, and Z. Klos, Natural noises and ionospheric mapping, *Adv. Space Res.*, *Ionospheric Informatics*, in press, 1988.
- Pulinets, S. A., and V. V. Selegey, Ionospheric plasma modification in near satellite region during topside sounding by powerful radio pulses, Preprint IZMIRAN, 4,(415), 25, 1983.
- Pulinets, S. A., and V. V. Selegey, Ionospheric plasma modification in the vicinity of a spacecraft by powerful radio pulses in topside sounding, *J. Atmos. Terr. Phys.*, 48, 149, 1986.
- Reinisch, B. W., and X. Huang, Automatic calculation of electron density profiles from digital ionograms, 1. Automatic O and X trace identification for topside ionograms, *Radio Sci.*, 17, 421, 1982.

- Serebryakova, M. V., The topside ionograms processing, Preprint IZMIRAN, 62,(595), 20, 1986.
- Sotsky, V. V., The height variations of electron concentration in the ionosphere on the ground-based, topside and transionospheric sounding data, Ph.D. thesis, 1986.
- Summary Plots of Ionospheric Parameters Obtained from Ionosphere Sounding Satellite-B*, issued by Radio Research Laboratories Ministry of Posts and Telecommunications, Japan, 1 - 4, 1983.
- Szuszczewicz, E. P., B. Fejer, R. Schunk, E. Roelof, and R. Wolf, SUNDIAL: An international program in solar-terrestrial physics, *WITS Handbook, 1*, 208, 1988, eds. C. H. Liu and Belva Edwards, SCOSTEP Secretariat, University of Illinois at Urbana-Champaign.
- Topside Sounding and the Ionosphere, Special Issue *Proc. IEEE*, 57, 1969.
- Vasiliyev, G. V., L. P. Goncharov, Yu. V. Kushnerevsky, V. V. Migulin, and M. D. Fligel, The satellite system IS-338 for pulsed sounding of the ionosphere, in *The Apparatus for Investigation of the Topside Ionosphere*, Moscow, 13, 1980a.
- Vasiliyev, G. A., A. A. Kalichev, Yu. A. Kapitonov, V. N. Knyazev, Yu. M. Kovalyov, E. V. Pogoda, V. P. Polyanski, and V. L. Rosin, The satellite ionospheric station ION-1, in *The Apparatus for Investigation of the Topside Ionosphere*, Moscow, 30, 1980b.
- Vasiliyev, G. V., I. Dmitriev, L. A. Emel'yanova, Yu. V. Kushnerevsky, M. D. Kulagin, V. V. Migulin, M. D. Fligel, I. P. Khar'kov, Yu. N. Shaulin, L. D. Shoya, and A. F. Yakovlev, On the same class of problems in the solar-terrestrial coupling investigation, *Doklady of USSR Acad. Sciences*, 257, 1117, 1981.
- Vidmar, R. J., and F. W. Crawford, Long-delayed radio echoes: mechanisms and observations, *J. Geophys. Res.*, 90, 1523, 1985.
- Warnock, J. M., Sideband structure observed by topside sounders, *Proc. IEEE*, 57, 1135, 1969.